



**BOTO Group Ltd.**

Add:Room 2304, Fortune Plaza, No.5616 Caoan , Anting Town, Jiading  
District, Shanghai, China

## Product description

### I Chamber picture



### II Product description

This equipment is to expose the product to a closed and constant temperature and humidity (optional) environment, after a period of environmental stress test to verify the thermal effect of the product after the parameter changes or other physical characteristics changes. It is a comprehensive standard reliability test instrument manufactured according to the variety and quantity of the user's experimental samples, the limited space of the laboratory site and the factors such as the entrance and exit aisle, door and use environment of the equipment. The following reliability tests can be provided: **high temperature storage, low temperature storage, high and low temperature cycle, double 85, combined temperature/humidity cycle (optional), constant wet heat, alternating wet heat and other single or combined cycle simulation reliability tests.**

### III Test standards

GB/T2423.1-2008 Test A: Low temperature test method  
 GB/T2423.2-2008 Test B: High temperature test method  
 GJB150.3A-2009 high temperature test  
 GJB150.4A-2009 Low temperature test  
 GB3423.22-2008 Test method for speed of temperature change  
 GBT2424.5-2006 Temperature test chamber performance confirmation  
 GB/T 10589-2008 low temperature test technical conditions  
 GB/T2423.3-2008 Test method for constant greenhouse  
 GJB150.9A-2009 Greenhouse test method  
 G/BT2423.4-2008 Alternating humid heat method  
 GB/T10586-2006 Wet heat test chamber technical conditions  
 GB/T2424.6-2006 Temperature/humidity test chamber performance confirmation  
 GB/T2424.7-2006 Measurement of temperature test chamber

### IV Specification

Model	B-TH-80 (A~G)	B-TH-150 (A~G)	B-TH-225 (A~G)	B-TH-408 (A~G)	B-TH-608 (A~G)	B-TH-800 (A~G)	B-TH-1000 (A~G)
Inside size WxHxD (cm)	40x50x40	50x60x50	50x75x60	80x85x60	80x95x80	100x100x80	100x100x100
Outside size WxHxD (cm)	95x145x105	105x175x97	115x190x97	135x185x120	145x185x137	145x210x130	147x210x140
Temperature range	0°C~+150°C (A:+25°C B:0°C C:-20°C D:-40°C E:-50°C F:-60°C G:-70°C)						
Humidity range	20%~98%R.H.(10%-98%R.H/5%~98%R.H is the specific condition)						

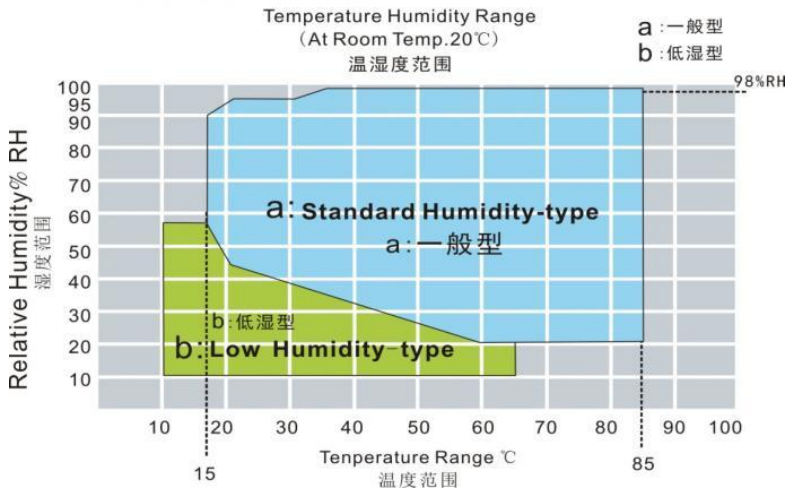
<b>V Performance</b>	
1. Temperature range	0°C~ +150°C
2. Humidity range	20%R.H ~ 98%R.H
3. Temperature and humidity chart	<p style="text-align: center;">◆ 温湿度可控制范围</p> <p style="text-align: center;">Temperature Humidity Range (At Room Temp. 20°C) 温湿度范围</p>  <p style="text-align: right;">a : 一般型 b : 低湿型</p>
4. Temperature deviation	≤ ±2.0 °C (no load, constant state)
5. Temperature resolution	0.1°C
6. Temperature uniformity	≤ ±2°C (no load, constant state)
7. Humidity fluctuation	±1.0%R.H
8. Humidity deviation	≤ ±2%R.H
9. Humidity uniformity	>75%RH: ≤±2-3%RH; <75%RH: ≤±3-5%RH (humid heat type only)
10. Humidity resolution	1.0%R.H
11. Heating time	3~5°C/min (non-linear no-load)
12. Cooling time	0.7~1.2°C/min (non-linear no-load)
<p>The above indicators are all tested and measured under ambient temperature ≤ 25°C, normal pressure, no load, no load conditions, and within 1/6 space from the inner wall of the chamber.</p>	

## VI Test environment

1. On-site temperature: 5°C~+28°C(average temperature within 24 hours ≤28°C);
2. Relative humidity: ≤85%RH;
3. Power supply conditions: Three-phase electricity;
4. Voltage range: AC380V;
5. Frequency allowed fluctuation range: (50±0.5)Hz;
6. The user is required to configure the air or power switch with the corresponding capacity for the equipment at the installation site, and the switch must be independent for the use of the equipment.

## VII Structural feature

1. Structure	Stainless steel construction
2. Material	<ol style="list-style-type: none"> <li>a. Inner chamber SUS304 stainless steel;</li> <li>b. Exterior stainless steel;</li> <li>c. Thermal insulation material: PU foam + glass wool.</li> </ol>
3. Door	<ol style="list-style-type: none"> <li>a. Single side door opening;</li> <li>b. 1 vacuum layer observation Windows with a set of lighting ;</li> <li>c. The window frame/door frame is equipped with electric heating (automatic adjustment) anti-frost and anti-condensation device;</li> <li>d. The door frame adopts high and low temperature resistant silicone rubber sealing strip.</li> </ol>
4. Control panel	<ol style="list-style-type: none"> <li>a. Temperature and humidity controller*1;</li> <li>b. Power push button switch*1;</li> <li>c. Observe window lighting switch*1;</li> <li>d. USB data export port*1.</li> </ol>
5. Pressure relief balance port	Bottom 1/2 inch pressure balance and drain common port *1.
6. Test hole	One φ50mm lead hole is opened on the left side of the instrument, and it is equipped with hole cover and silicone rubber plug.
7. Wheel	The bottom of the instrument is equipped with 4 moving casters and 4 horizontal fixed foot cups.



**VIII Standard configuration**





1. Programmable TMIE880 color touch screen;
2. Two control methods (fixed value/program);
3. Sensor type: PT100 sensor (electronic sensor optional);
4. Alarm signal: 4 DI external fault alarms;
5. Temperature measurement range: -90.00°C ~ 200.00 °C;
6. Humidity measurement range: 1.0%~100%R.H., error 1%R.H.
7. Interface language type: Chinese/English.



1. Ultra-high energy efficiency. The energy efficiency ratio is 12% higher than the most advanced piston compressor currently on the market.
2. Outstanding reliability. With fewer moving parts, the axial and radial Taikang patented flexible design provides unprecedented resistance to liquid impact and the ability to tolerate impurities.
3. The built-in motor circuit breaker can effectively protect the motor from damage due to high temperature and high current.
4. Low noise/low exhaust pulse noise value is more than 5 decibels lower than that of piston compressors
5. Simplify the system design. The unique unloading start design eliminates the need for a starting capacitor/relay when starting the single-phase compressor.
6. Nearly 100% volumetric efficiency brings extraordinary heating capacity
7. The compressor produced by Taikang is a high-efficiency, low-slip large-volume F-class insulated motor, which ensures the compressor's high cooling capacity, low power consumption and operational safety.
8. The optimal balance design of Taikang compressor makes the compressor have small vibration, low noise and more stable operation.

	<p>Advantages of stainless steel fin electric heating tube:</p> <p>Compared with ordinary heating tubes, heat sink (fin type) heating tubes have the following advantages:</p> <p>Compared with ordinary light pipes, the heat dissipation area of finned tubular electric heating pipes increases by 2.5 to 4 times, and the surface load increases by 2 to 3 times compared with light pipes. Due to the shortened length of the heat sink electric heating device, its own heat Losses are reduced. Under the same power conditions as the light tube, it has the advantages of fast heating, high thermal efficiency, and long service life; in a limited heating device, it can accommodate a total power of 2 to 3 times the capacity of the super light tube, greatly reducing the size of the heating device. , saving user costs;</p>
	<p>Physical properties:</p> <ol style="list-style-type: none"> <li>1. Composition: R-125/143A/134A;</li> <li>2. Mass ratio of each component: 44/52/4;</li> <li>3. Molecular weight: 97.6;</li> <li>4. Boiling point: 101.3kpa°C-46.2;</li> <li>5. Critical temperature °C: 72.1;</li> <li>6. Critical pressure: kpa 3728;</li> <li>7. Saturated liquid density: 25°CKg/m³1044;</li> <li>8. Specific heat: 25°CKj/(kg.k) 1.54;</li> <li>9. Ozone depletion potential (ODP): 0;</li> <li>10. Specific heat of isobaric steam: (Cp), 30°C and 101.3kPa [KJ/(Kg·°C)] 0.21;</li> <li>11. Evaporation potential at boiling point: KJ/Kg 200.1.</li> </ol>

	<p>Fan features:</p> <ol style="list-style-type: none"> <li>1. The wind wheel is multi-wing type, with high-speed dynamic balance correction, large air volume and low noise.</li> <li>2. The air casing is stamped with precision molds and processed by electrophoresis, with a beautiful appearance.</li> <li>3. Equipped with certified high-efficiency motor, direct-connected installation, stable performance</li> <li>4. The air outlet comes with square to round accessories, and the installation angle can be adjusted in multiple directions.</li> <li>5. Optimized design of air duct, obvious energy saving effect</li> <li>6. The fan can be made of special materials and can be processed with special properties such as stepless speed change.</li> <li>7. Fan matching motors can be customized with different frequencies or voltages, AC or DC.</li> </ol>
	<ol style="list-style-type: none"> <li>1. Fin type: corrugated fin or flat fin.</li> <li>2. The copper tube is made of high-purity seamless copper tube, which has a long life and is not easy to break and corrode.</li> <li>3. The coil frame end plate is made of high-quality steel plate, which has high strength, corrosion resistance and is easy to assemble and assemble.</li> <li>4. The unique cross-tube method ensures uniform liquid distribution on the entire windward area of the coil.</li> <li>5. The fins and copper tubes are mechanically expanded or ultra-high-pressure hydraulically expanded to ensure close contact and achieve the best heat exchange effect.</li> <li>6. The selectivity of the spacing between the sets is large, which reduces the impact of frost accumulation on the coils of the low-temperature system.</li> <li>7. The inner loop of the coil uses a single or double return system according to the design flow rate requirements, with small water resistance and good heat exchange performance.</li> </ol> <p>The refrigerant coil is heated at high temperature and vacuum dried to ensure</p>

	<p>that there is no impurity and moisture in the cavity.</p>
	<ol style="list-style-type: none"> <li>1. Specifications: 100-gallon Taiwan famous brand Deng Yuan water pump, universal for household pure water machines</li> <li>2. Input voltage: 24VDC (direct current)</li> <li>3. Working current: 0.6AMP</li> <li>4. Working pressure: 125PSI</li> <li>5. Working flow: 0.85L/M</li> <li>6. Net weight: 1.8 kg</li> <li>7. Self-priming distance: 2M</li> <li>8. Volume: 18*10*10cm<sup>3</sup></li> </ol>
	<p>Features:</p> <p>The 3/8 "copper pipe and pitted aluminum sheet are used, and the aluminum sheet is closely fitted with the copper tube through mechanical expansion tube, which has high heat transfer efficiency. The product has been tested by 2.5MPa pressure test for leakage, leaving the factory and retaining 0.05MPa ~ 0.1MPa pressure; Can be used in R22, R134a, R404A and other refrigeration working medium, widely used in a variety of freon refrigeration equipment using FN type condenser selection of high-power, large air volume, low speed motor, and built-in installation, beautiful appearance, low noise, can be used in the unit with low noise; FNV condenser has large windward surface, good heat transfer effect, 6-pole motor and low noise; It can be used in large condensing units. Various types of air condensers can be designed according to customer requirements.</p>
<p><b>十三、 Safety protection device</b></p>	
<p>1、 Refrigerating system</p>	<ol style="list-style-type: none"> <li>a. Compressor overheat protection;</li> <li>b. Compressor overpressure protection;</li> <li>c. Compressor overcurrent protection.</li> </ol>

2、 Laboratory	<p>a. Adjustable overtemperature protection;</p> <p>b. Humidifier dry burning protection (when selecting humidity);</p> <p>c. Motor overheat protection;</p> <p>d. Abnormal water supply alarm and protection (when purchasing humidity).</p>
3、 Other	Total power supply phase loss, leakage, overload, short circuit protection;

#### 十四、 Accessories and data

- 1、 Storage rack (stainless steel, adjustable height of storage rack);
- 2、 A copy of manual.

#### 十五、 Equipment installation site and operating conditions

##### 1. Site requirements

- a. Ground level, good ventilation, free of flammable, explosive, corrosive gases and dust;

It's better to have air conditioning.

- b. There is no strong electromagnetic radiation

source nearby;

- c. There are floor drains (condensate water)

near the equipment;

- d. Ground bearing capacity: not less than 500kg/m<sup>2</sup>;

- e. Proper maintenance space around the equipment (see figure)

A: ≥ 60cm B: ≥ 60cm C: ≥ 100cm D: ≥ 60cm

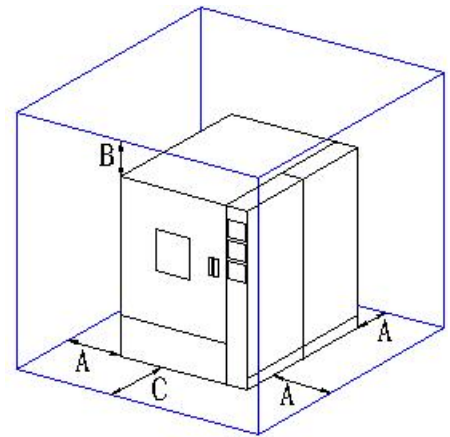

## Configuration list

<b>Cooling System</b>	<b>Material name</b>
Compressor	Tecumseh (France)
Condenser	Fin type equipped with cooling fan (Keweili)
Evaporator	Customized (BOTO)
Expansion valve	Danfoss/Honeywell(Denmark)
Electromagnetic valve	FDF
Electromagnetic valve	FDF
Pressure controller	Danfoss(Denmark)
Oil separator	S-4004(Taiwan)
Filter	EMERSON
Refrigerant: R404A	Honeywell
Copper pipes and other parts	Taishun (Taiwan)
<b>Measurement and control system</b>	<b>Material name</b>
Temp and humidity control instrument	TEMI880(Color screen touch)
Over-temperature protection instrument	EGO(Chint)
Temperature Sensor	Pt100
Humidity Sensor	Pt100
Contactator	CJX2(Chint)
Solid state relay	SSR(Taiwan Yang Ming)
Time delay relay	ANV(Taiwan Yang Ming)
Intermediate relay	Omron(Japan)
Heating rod	1 Kw(Customized)
Switching power (leakage protection)	DZ47LE(Chint)
Transformer	Customized
Control switch panel	Customized
Audible alarm	Taian (Taiwan)
Heater protection	Taian (Taiwan)

## Factory real pictures display

### 1. Certificate

ISO certificate



Some patents (nearly 100) and certificates



Some patents (nearly 100) and certificates



2. Shanghai Office :



3. Factory environment area



Work shop



Our team

#### 4. Spot exhibition hall area\finished product area



#### 5. BOTO GROUP Factory located in Hunan Yueyang Industrial Park.

The industrial park is constructed by Shanghai Boyi Test Equipment Co., LTD with a total investment of RMB 400 million. Mainly engaged in the research and development and manufacturing of the whole chain of laboratory equipment; It is located next to Yueyang section of Wuhan-Guangzhou high-speed railway, adjacent to Lotus Airport, and has very convenient transportation. The industrial park covers an area of 40 mu, consisting of a comprehensive office building and two standard factories, with a total construction area of nearly 20,000 square meters



**Showroom 1**



**Showroom 2**



6. On December 23, 2021, Li Aiwu, deputy Secretary of CPC Committee and Mayor of Yueyang city, Hunan Province, led the participants of Yueyang City industrial project construction mobile site meeting to inspect our company and observe the construction of industrial projects.



7. After the industrial park is fully put into operation, it can meet the annual output of new energy 3C semiconductor electronic circuit optical communication industry laboratory testing room environment simulation box 1200 sets; Another company has an independent sheet metal production and processing center, can independently undertake manufacturing business.

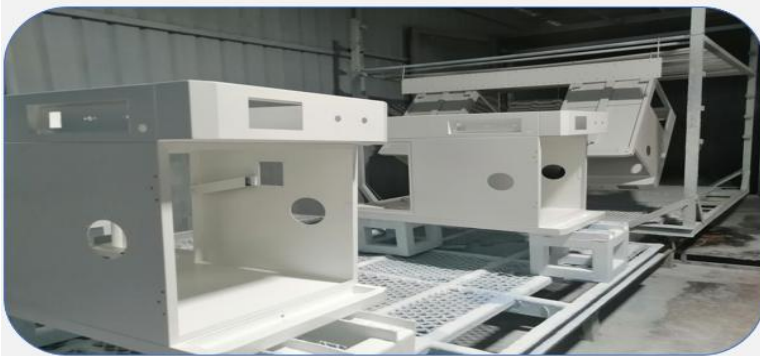

**8. Standard size machine**

**225L High and Low Temperature Humidity  
and Heat Alternating Test Chamber**



225L

**20 L constant temperature  
and humidity test chamber**

**Overlapping Temperature and humidity chamber**



B-TH-432



**Thermalshock test chamber**

**Double layer constant temperature test chamber**

**Salt spray test chamber**



**150L Vertical high and low  
temperature test chamber**



**Ventilation type aging test chamber**



**Leaning tower ultraviolet aging  
test chamber**

**9 .Large non-standard real pictures display area**



**3.6 m3 constant temperature  
humidity laboratory**



**9 cubic meters low temperature room,  
13 cubic meters high temperature room**



**Three comprehensive and  
test chamber**



## 10. Shipment



Self-produced and sold No dealer link



Save you 30%



Quality and after-sales are recognized by customers

